

A (x1)

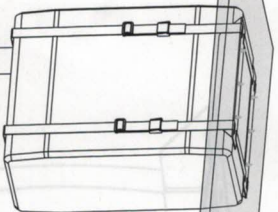

B (x6)

The product can hold a CPU vertically and horizontally.



OR

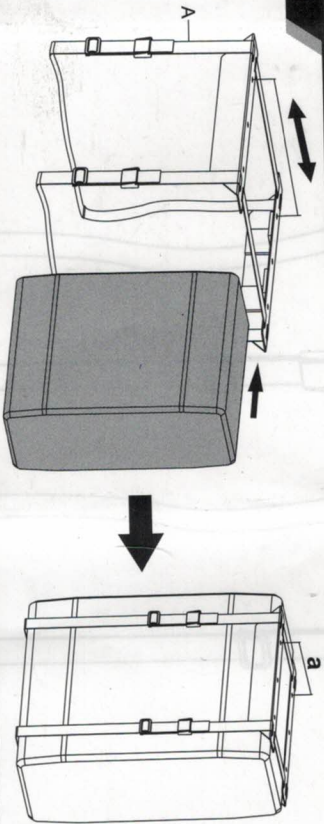
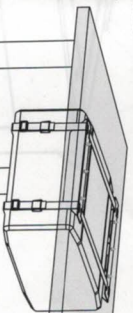

2

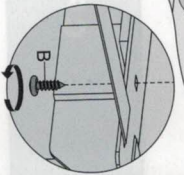
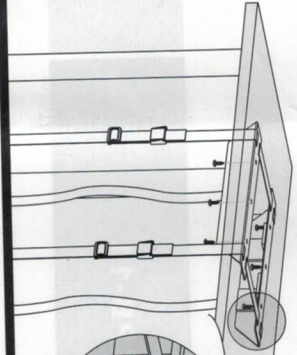
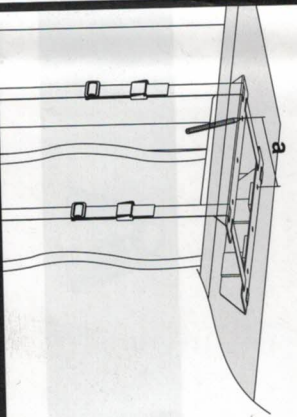
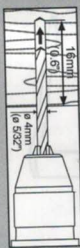

3

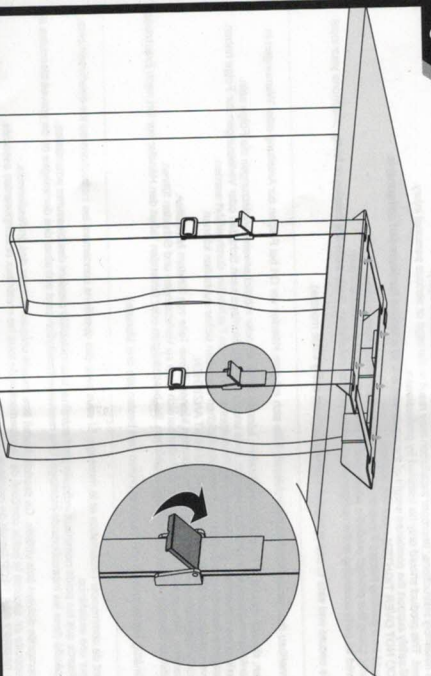

4

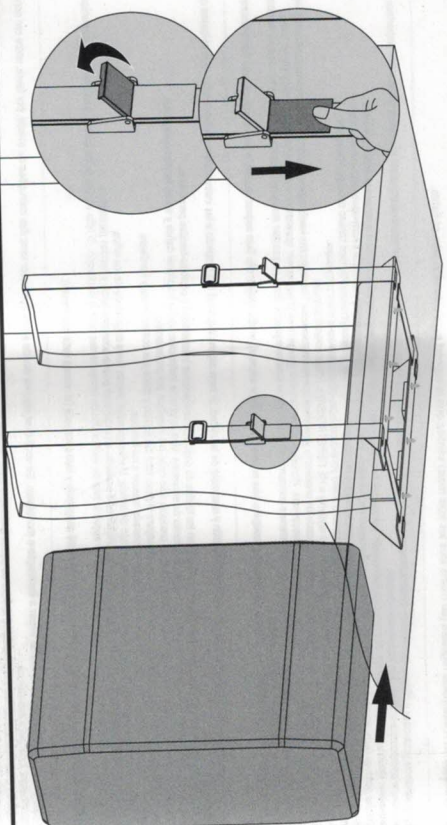

5

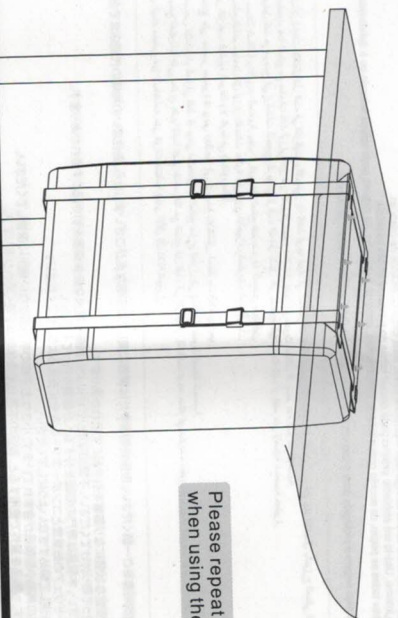

Please repeat the same process when using the product horizontally.